

KOPEN[®]
ALUMINUM DOORS

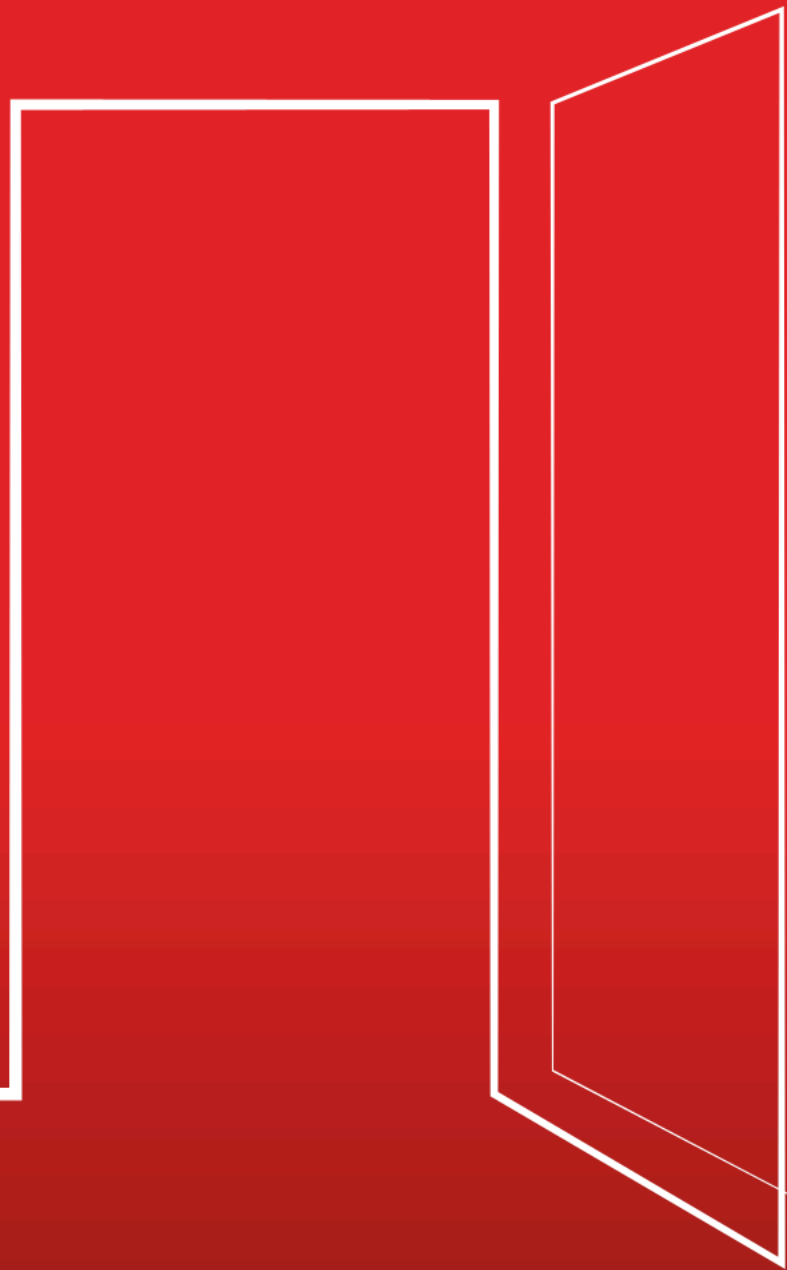

Sistema KDS 90



KOPEN APRI
AD UN NUOVO
MONDO



TAPLUX



CHI SIAMO

Kopen è protagonista nel mercato della produzione di **porte d'ingresso in alluminio**, grazie ad un personale con un'esperienza ultradecennale, in grado di garantire un servizio sempre ai massimi livelli per **servizio, e scienza e sicurezza**.

Il suo **Made in Italy** manifatturiero risiede ad **Aielli** nel cuore dell'Abruzzo: una combinazione di abilità produttive, capacità creativa e innovazione, valorizzato dalla cultura del lavoro. O re porte d'ingresso di **design** che comunicano il loro stile dentro e fuori con finiture e particolari di **qualità**.

PRESTAZIONI



TENUTA ALL'ACQUA
(UNI EN 1027, 12208)
E1200



PERMEABILITÀ ALL'ARIA
(UNI EN 1026, 12207)
Classe 4



RESISTENZA AL VENTO
(UNI EN 12211, 12210)
Classe C5



TRASMITTANZA TERMICA
(UNI EN ISO12567-2)
Ud = 0,79 W/mq*K



CLASSI ANTIEFFRAZIONE
(UNI EN 1627:2011)
Fino a RC3

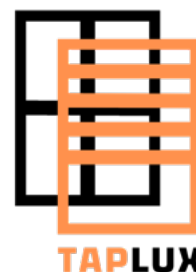

K

SistemaKDS 90

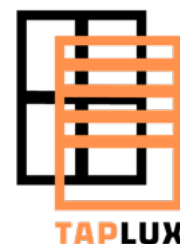

- Realizzato con profili estrusi in alluminio lega UNI 6060
- Taglio termico anta e telaio con barrette in poliammide caricata a vetro (PA6)
- Lamiere di rivestimento in alluminio spessore da 1,5 mm, con disegno a scelta, sia cieche che con triplo vetro
- Sistema di tenuta a 3 guarnizioni, con angoli prestampati per garantire la continuità lungo il perimetro
- Soglia in alluminio a taglio termico con altezza 24 mm
- Cerniere cilindriche in acciaio zincato con cappucci di copertura e regolazione su 3 assi
- Possibilità di applicazione coprifili a scatto sia interni che esterni, applicazione di imbotti per cappotto e sta e per fissaggio frontale
- Le dimensioni sono da considerarsi standard sino a 1.100 x 2.250 mm (dimensioni riferite alla porta ad un'anta - esterno telaio), mentre i fuori standard sono realizzabili fino ad un massimo di 1.200 x 2.450

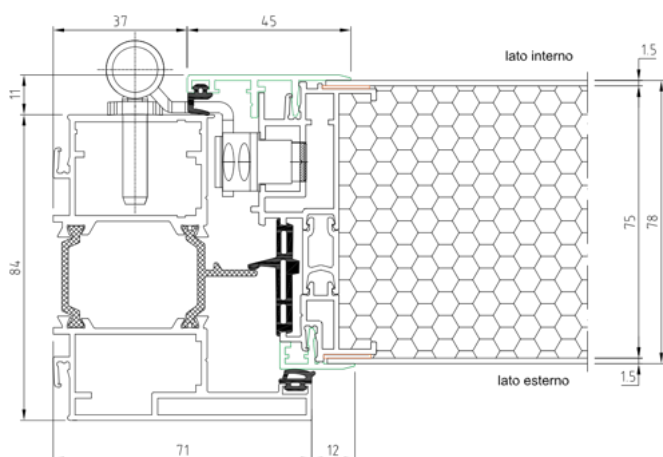

DOTAZIONI STANDARD

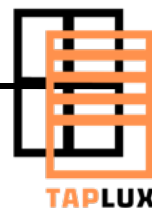

**CILINDRO EUROPEO
FRIZIONATO 5 CHIAVI
+ CHIAVE DA CANTIERE**

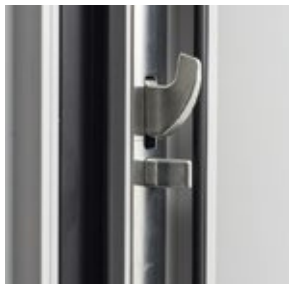

**SERRATURA MECCANICA CON
INCONTRI SCIOLTI
+ GANCI E PUNZONI A 3 PUNTI**



**ANELLO DEFENDER
DI SICUREZZA**



**MANIGLIA INTERNA
E POMOLO ESTERNO
IN ALLUMINIO ARGENTO**



**2 CERNIERE 3D A 2 ALI
IN ACCIAIO ZINCATO CON
CAPPUCCI IN ALLUMINIO
IN 5 FINITURE**

Bianco 9016 Nero 9005 OP Argento Satinato

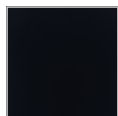

Bronzo Satinato Ottone Lucido

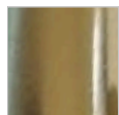

FINITURE CERNIERE

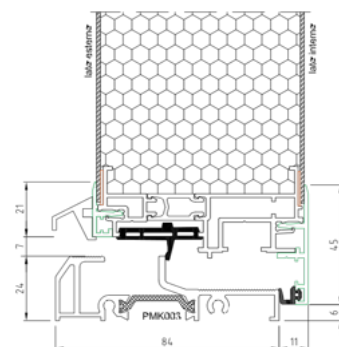

**SOGLIA RIBASSATA OSSIDATO
ARGENTO O NERO CON ALTEZZA
24 MM**

DOTAZIONI OPZIONALI

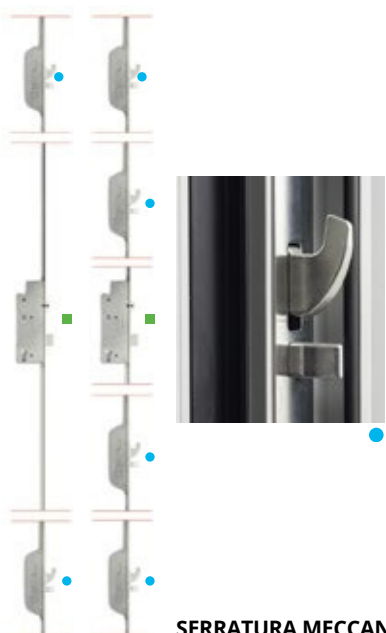

SERRATURA MECCANICA 3 E 5 PUNTI



**SERRATURA RIARMO
AUTOMATICO
3 E 4 PUNTI
(MOTORIZZABILE)**

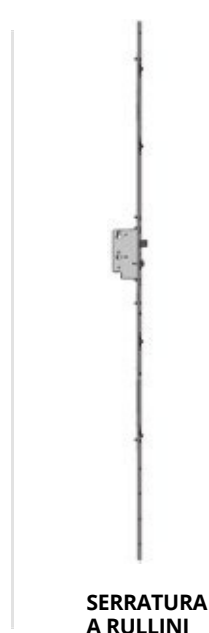

**SERRATURA
A RULLINI**

PORTA A VETRO



VETROCAMERA con dimensioni variabili in base al modello realizzato con 2 CAMERE e 3 LASTRE DI VETRO. Spessore totale 73 mm. Semicomplanare all'anta di spessore 78 mm.

COMPOSIZIONE DEL VETROCAMERA STANDARD 33.1 PL. SAT/C/4/C/33.1 PL. SAT (J22)

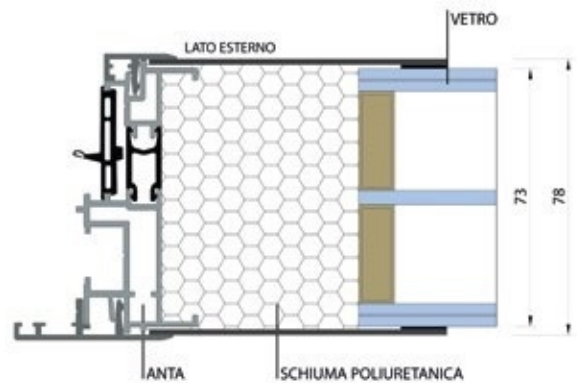

FIANCHILUCE E SOPRALUCE

Le tipologie FIANCOLUCE e SOPRALUCE sono prodotte separatamente e disponibili con telaio standard da 48 mm e maggiorato da 71 mm.

COMPOSIZIONE DEL VETROCAMERA DA 52 MM: 33.1 PL. SAT/C/4/C/33.1 PL. SAT (J22)

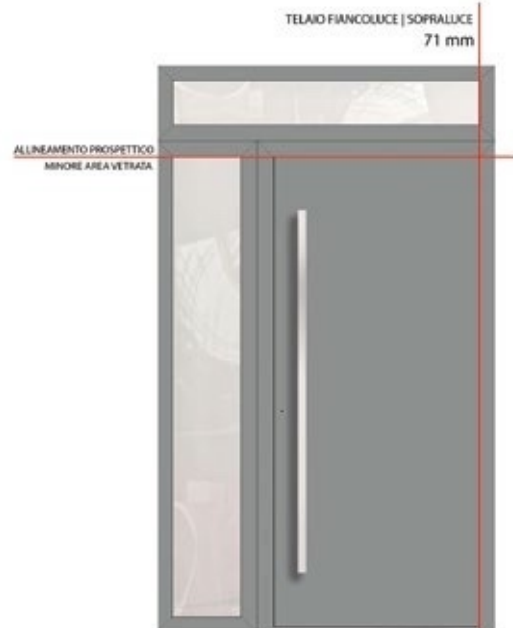
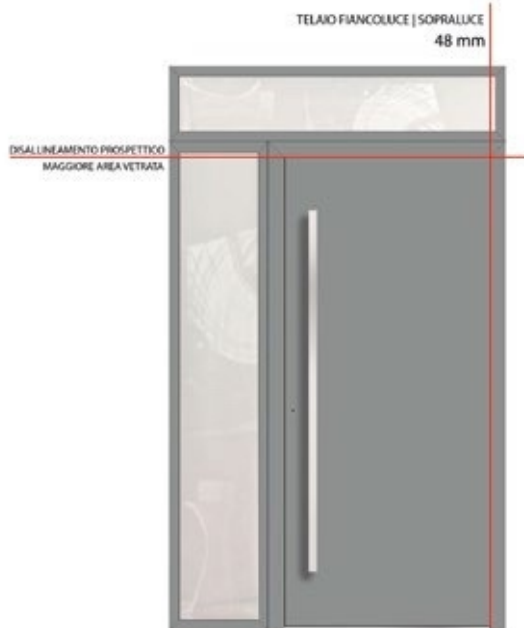

TIPOLOGIE

LA PORTA D'INGRESSO IN ALLUMINIO KOPEN NASCE PER SODDISFARE AL MEGLIO QUALSIASI ESIGENZA, ED È PER QUESTO CHE OGNI PRODOTTO È REALIZZATO SEMPRE SU MISURA DANDO VITA AD UN MODELLO UNICO.

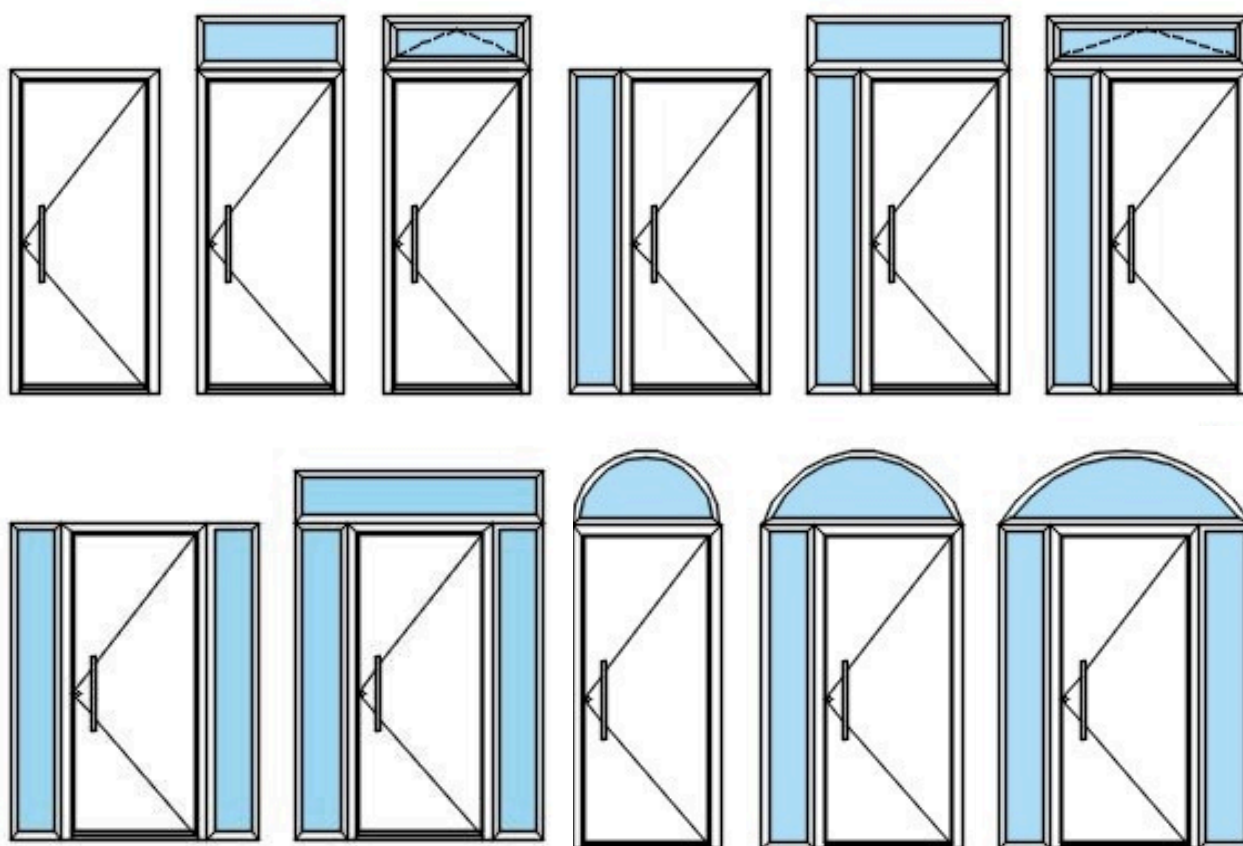

VETRI

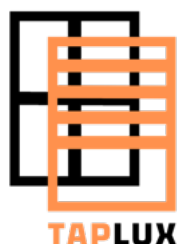

J22
SATINATO BIANCO B.E.

J14
SATINATO BRONZE B.E.

J15
SATINATO FUMÈ B.E.

J27
RIFLETTENTE ANTELIO
CHIARO B.E.

MODELLI

Linea VITRUM



VI 17 KP



VI 02 KP



VI 01 KP



VI 06 KP



VI 15 KP



VI 05 KP



VI 03 KP



VI 07 KP



VI 11 KP



VI 12 KP



VI 13 KP



VI 04 KP



VI 14 KP



VI 18 KP



VI 19 KP



VI 21 KP

Linea CLASSIC



CL 01 KP



CL 03 KP



CL 04 KP

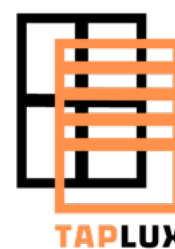

TAPLUX

Linea PURE



PU 02 KP



PU 01 KP



PU 03 KP



PU 04 KP



PU 08 KP



PU 09 KP



PU 14 KP



PU 16 KP



PU 12 KP



PU 17 KP



PU 15 KP

Linea STYLE



ST 01 KP



ST 02 KP



ST 10 KP



ST 05 KP



ST 07 KP



ST 04 KP



ST 08 KP

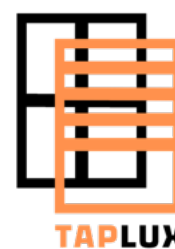

TAPLUX

ACCESSORI INTERNI

MANIGLIERIA INTERNA



MAN K01 J01
■ ALLUMINIO ARGENTO



MAN K02 J08
■ ALLUMINIO ORO



MAN K03 J09
■ ALLUMINIO BRONZO



MAN K04 J05
■ ACCIAIO INOX SAT.



MAN K05 J12
■ OTTONE LUCIDO



MAN K17 J02
■ NERO OPACO



MAN K06 J01
■ ALLUMINIO ARGENTO



MAN K07 J05
■ ACCIAIO INOX SAT.



MAN K14 J11
■ OTTONE CROMO SAT.



MAN K08 J01
■ ALLUMINIO ARGENTO



MAN K09 J05
■ ACCIAIO INOX SAT.



MAN K10 J01
■ ALLUMINIO ARGENTO



MAN K11 J05
■ ACCIAIO INOX SAT.



MAN K15 J05
■ ACCIAIO INOX SAT.



MAN K16 J05
■ ACCIAIO INOX SAT.

POMOLI GIREVOLI



POM E08 J01
■ ALLUMINIO ARGENTO



POM E09 J09
■ ALLUMINIO BRONZO



POM E10 J10
■ OTTONE LUCIDO
RESISTA



SPI K01 J11
■ OTTONE CROMO SAT.

POM E09 J09
■ ALLUMINIO BRONZO

SPI K03 J12
■ OTTONE LUCIDO

NOTTOLINO



NOT K01 J01
■ ALLUMINIO ARGENTO

NOT K02 J09
■ ALLUMINIO BRONZO

NOT K03 J11
■ OTTONE CROMO SAT.

NOT K04 J12
■ OTTONE LUCIDO



NOT K01 J01
■ ALLUMINIO ARGENTO

NOT K06 J11
■ OTTONE CROMO SAT.

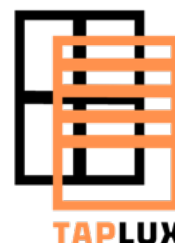

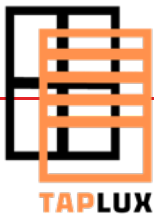

ACCESSORI ESTERNI

MANIGLIONI ESTERNI

CODICE	LUNGHEZZA (mm)
MSX E01 J05	1600
MSX E02 J05	1200
MSX E03 J05	800
MSX E04 J05	500

■ ACCIAIO INOX SATINATO

CODICE	LUNGHEZZA (mm)
MSX E05 J05	160
MSX E06 J05	0
MSX E07 J05	120
MSX E08 J05	0
	800
	500

■ ACCIAIO INOX SATINATO

CODICE	LUNGHEZZA (mm)
MSX E12 J05	160
MSX E13 J05	0
MSX E14 J05	120
	0
	800

■ ACCIAIO INOX SATINATO

CODICE	LUNGHEZZA (mm)
MSX E15 J05	160
MSX E16 J05	0
MSX E17 J05	120
	0
	800

■ ACCIAIO INOX SATINATO

CODICE	LUNGHEZZA (mm)
MSX E10 J05	1600
MSX E11 J05	600

■ ACCIAIO INOX SATINATO

CODICE	LUNGHEZZA (mm)
MSX E18 J05	160
MSX E19 J05	0
MSX E20 J05	120
	0
	800

■ ACCIAIO INOX SATINATO

CODICE	LUNGHEZZA (mm)
MSX E40 J05	112
MSX E40 D2	8
	112
	8

■ ACCIAIO INOX SATINATO
■ NERO OPACO

CODICE	LUNGHEZZA (mm)
MSX E27 J05	500
INTERASSE	350

■ ACCIAIO INOX SATINATO

CODICE	INTERASSE (mm)
MSX E28 J10	203

■ OTTONE LUCIDO RESISTA

CODICE
MSX E31 J03
INTERASSE (mm)
203

■ OTTONE ARGENTO ANTICO

CODICE
MSX E31 J02
INTERASSE (mm)
203

■ NERO OPACO

CODICE
MSX E39 J05
INTERASSE (mm)
300

■ ACCIAIO INOX SATINATO

CODICE
MSX E29 J11
INTERASSE (mm)
180

■ OTTONE CROMO S SATINATO

CODICE
MSX E30 J10
INTERASSE (mm)
180

■ OTTONE LUCIDO RESISTA

CODICE
MSX E31 J02
INTERASSE (mm)
210

■ BRONZO

DEFENDER



DEF E05 J11
■ OTTONE CROMO SAT.

DEF E07 J02
■ NERO OPACO

DEF E06 J12
■ OTTONE LUCIDO

DEF E08 J09
■ BRONZO

POMOLI FISSI

POM E01 J01
■ ALLUMINIO ARGENTO

POM E02 J11
■ OTTONE CROMO SAT.

POM E03 J10
■ OTTONE LUCIDO RES.







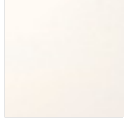

POM E04 J09
■ ALLUMINIO BRONZO

POM E05 J01
■ ALLUMINIO ARGENTO











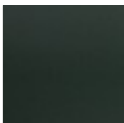
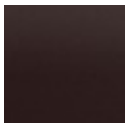

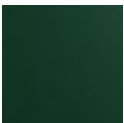









POM E06 J05
■ ACCIAIO INOX SAT.

POM E07 J11
■ OTTONE CROMO SAT.

RAL STANDARD

K83  9016 R TX	K73  9010 R TX	K74  1013 R TX	K75  9006 R TX	K76  9007 R TX
K77  7001 R TX	K78  7016 R TX	K79  9005 R TX	K80  6005 R TX	Y78  8017 R TX

RAL SPECIAL

K13  P V	K14  P M	K15  P G CE	K17  6005 MA	K23  P G R	K24  PGMA
K42  P GRAF	K81  8014 R TX	K86  7035 R TX	K87  7037 R TX	K88  7039 R TX	K90  5010 R TX
K91  6009 R TX	K93  SK13SD	K94  SK14SD	K95  SK15SD	K96  SK16SD	K97  1019 R TX
K98  7006 R TX	K99  8019 R TX	F01  6021 R TX	F12  7040 R TX	F16  3003 R TX	

EFFETTO LEGNO STANDARD

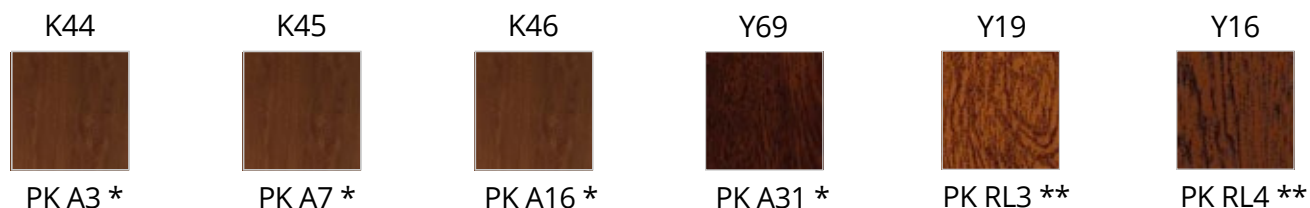

* finiture *SUBLIMATE* (decorazione da pellicola) realizzabili su lavorazioni incise

** finiture *RELIF* (polvere su polvere) realizzabili su lavorazioni fresate

EFFETTO LEGNO/METALLIKA SPECIAL

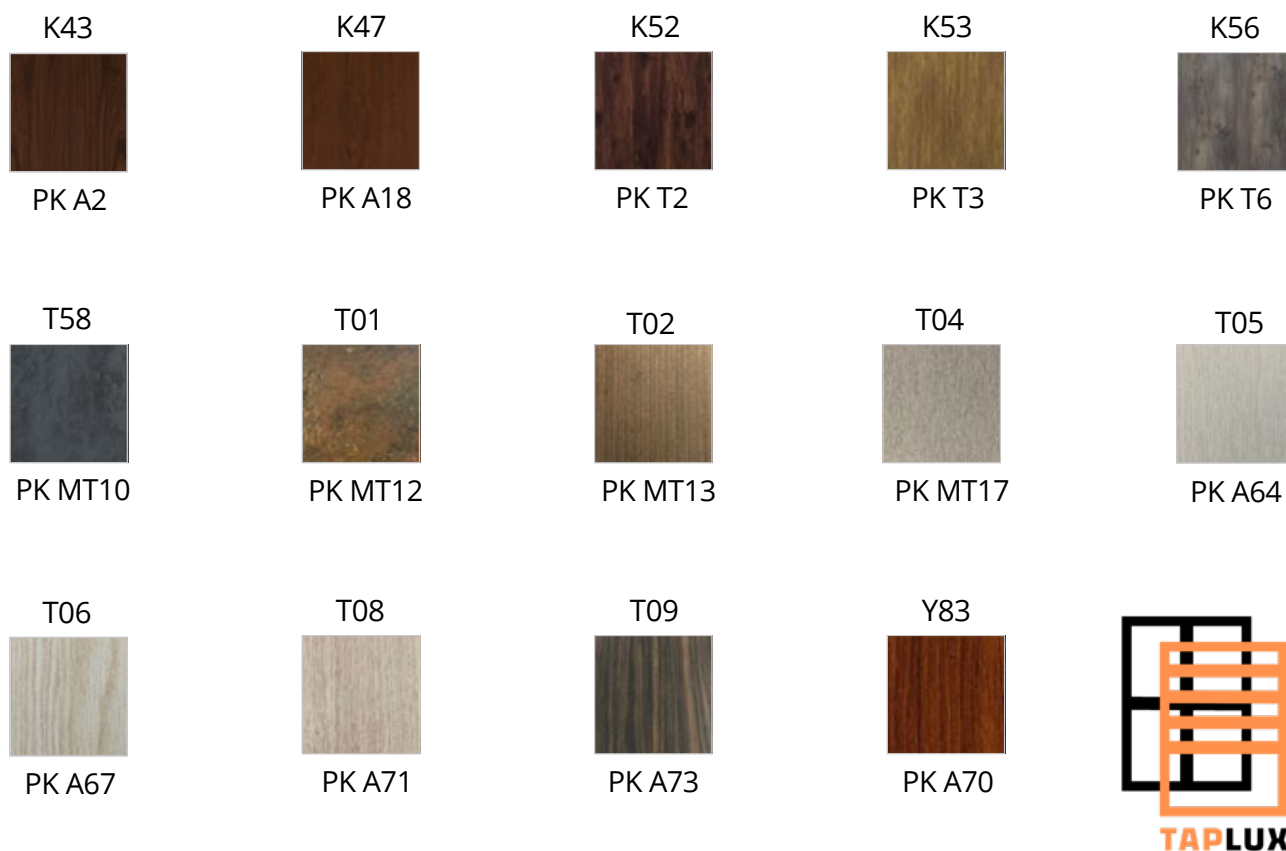

RAL FUORI CAMPIONARIO

Possono essere richieste altre finiture RAL fuori campionario, previa fattibilità della KOPEN.

Le finiture realizzabili fanno parte della serie Texture (finiture lucide ed opache non sono realizzabili per motivi qualitativi).

SCEGLIERE UNA PORTA DI INGRESSO KOPEN VUOL DIRE SCEGLIERE UN PRODOTTO RESISTENTE, DI QUALITÀ, GARANTITO PER DURARE NEL TEMPO.

GARANZIA

Le Porte Kopen sono state ideate per fare di ogni abitazione un luogo di design esclusivo e sicuro. In ogni prodotto si ritrova tutto il sapere del MADE IN ITALY Kopen per essere sempre al fianco di ogni cliente. **Le porte Kopen sono garantite 15 anni sulla piena funzionalità e sulla verniciatura.**

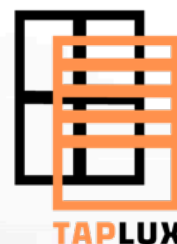



KOPEN[®]
ALUMINUM DOORS



KOPEN S.r.l.

Via Tiburtina Valeria Km. 127,5 CAP 67041 – Aielli (AQ) - Italia
info@kopendoors.com

+39 0863 78861 

www.kopendoors.com

